

Valve Manifolds, VM10 Series

Valve slices 2x3/2, 5/2, and 5/3 with integral push-in fittings



Multipole or individually wired for installation flexibility

Interchangeable Fieldbus compatible modules

Compact and lightweight

High flow exhaust paths

Quick disconnect base (Pneumapole)

High flow from 10 mm valve width

Technical Data

Medium:

Compressed air, filtered, lubricated and non-lubricated

Operation:

Solenoid pilot spool valve

Port sizes:

Push-in fittings of 1/8, 5/32, 1/4, 3 mm, 4 mm, 6 mm.

Tube types:

Nylon 11 or 12, polyurethane* and other plasticized or unplasticized tubing conforming to the tolerances specified in DIN 73378, NFE 49-101, ISO/WD 16026, ISO/WD 16627.

*Suitable for 85D

Operating pressure:

Maximum 116 psig (8 bar)

Flow:

Function	Cv	l/min
5/2	0.44	430
2 x 3/2	0.36	350
5/3	0.36	350

Degree of protection:

NEMA 4 and IP65

Ambient temperature:

4°F to 122°F (-20°C to +50°C)

For use below 36°F (+2°C) consult our Technical Service

Materials

Aluminum spool with nitrile rubber seals

Body, end plates: engineered PPA co-polymer

Electrical details

Voltage:	24 V d.c. 0.6 W
Surge suppression:	Flywheel diode
Indication:	Yellow LED

Solenoids

Voltage tolerance:	± 10%
Rating:	100% ED

Options selector

VM109517AB313B

Tube size	Substitute
3 mm PIF	3
4 mm PIF	4
6 mm PIF	6
1/8" PIF	A
1/4" PIF	1
5/32" PIF	9
No PIF (for use with Pneumapole)	7*

Valve function	Substitute
5/2	5
5/3 APB	6
2 x 3/2 NC and 5/3 COE	A
2 x 3/2 NO and 5/3 COP	B
2 x 3/2 NC and NO	C

Manual override	Substitute
Turn to lock manual override	2
Push only manual override	3

Exhaust	Substitute
Standard open exhaust	A

Actuation/pilot supply	Substitute
Solenoid/solenoid internal pilot	11
Solenoid/spring internal pilot **	17
Solenoid/solenoid external pilot	22
Solenoid/spring external pilot **	27

Note: For 5/3 COE please use 2 x 3/2 NC. For 5/3 COP please use 2 x 3/2 NO
 APB = All Ports Blocked COE = Center Open Exhaust COP = Center Open Pressure
 Use our configurator under www.norgren.com.

* Requires Pneumapole sub-base ** Can only be used with 5/2 valve

Valve Manifolds, VM10 Series

Valve slices 2x3/2, 5/2, and 5/3 with integral push-in fittings

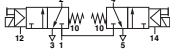
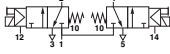
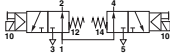
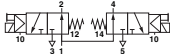
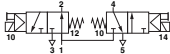
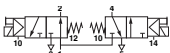
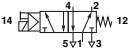
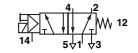
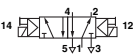
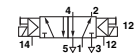
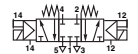
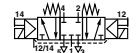
	2 x 3/2 Double solenoid actuated	Manual override	Function	Pilot Supply	Actuation	Operating Pressure (psig)	Pilot Pressure (psig)	Weight (lbs)
	VM10*A11AB213B	Turn & lock	NC	Internal	Sol/Spring	43.5 to 116	–	0.12
	VM10*A11AB313B	Push only	NC	Internal	Sol/Spring	43.5 to 116	–	0.12
	VM10*A22AB213B	Turn & lock	NC	External	Sol/Spring	26" Hg to 116	43.5 to 116	0.12
	VM10*A22AB313B	Push only	NC	External	Sol/Spring	26" Hg to 116	43.5 to 116	0.12
	VM10*B11AB213B	Turn & lock	NO	Internal	Sol/Spring	43.5 to 116	–	0.12
	VM10*B11AB313B	Push only	NO	Internal	Sol/Spring	43.5 to 116	–	0.12
	VM10*B22AB213B	Turn & lock	NO	External	Sol/Spring	26" Hg to 116	43.5 to 116	0.12
	VM10*B22AB313B	Push only	NO	External	Sol/Spring	26" Hg to 116	43.5 to 116	0.12
	VM10*C11AB213B	Turn & lock	NC/NO	Internal	Sol/Spring	43.5 to 116	–	0.12
	VM10*C11AB313B	Push only	NC/NO	Internal	Sol/Spring	43.5 to 116	–	0.12
	VM10*C22AB213B	Turn & lock	NC/NO	External	Sol/Spring	26" Hg to 116	43.5 to 116	0.12
	VM10*C22AB313B	Push only	NC/NO	External	Sol/Spring	26" Hg to 116	43.5 to 116	0.12
5/2 Single and double solenoid actuated valves								
	VM10*517AB213B	Turn & lock	5/2	Internal	Sol/Spring	43.5 to 116	–	0.10
	VM10*517AB313B	Push only	5/2	Internal	Sol/Spring	43.5 to 116	–	0.10
	VM10*527AB213B	Turn & lock	5/2	External	Sol/Spring	26" Hg to 116	43.5 to 116	0.10
	VM10*527AB313B	Push only	5/2	External	Sol/Spring	26" Hg to 116	43.5 to 116	0.10
	VM10*511AB213B	Turn & lock	5/2	Internal	Sol/Sol	29 to 116	–	0.12
	VM10*511AB313B	Push only	5/2	Internal	Sol/Sol	29 to 116	–	0.12
	VM10*522AB213B	Turn & lock	5/2	External	Sol/Sol	26" Hg to 116	29 to 116	0.12
	VM10*522AB313B	Push only	5/2	External	Sol/Sol	26" Hg to 116	29 to 116	0.12
5/3 Double solenoid actuated valves								
	VM10*611AB213B	Turn & lock	5/3 APB	Internal	Sol/Sol	43.5 to 116	–	0.12
	VM10*611AB313B	Push only	5/3 APB	Internal	Sol/Sol	43.5 to 116	–	0.12
	VM10*622AB213B	Turn & lock	5/3 APB	External	Sol/Sol	26" Hg to 116	43.5 to 116	0.12
	VM10*622AB313B	Push only	5/3 APB	External	Sol/Sol	26" Hg to 116	43.5 to 116	0.12

Valve Manifolds, VM10 Series

Valve slices 2x3/2, 5/2, and 5/3 with integral push-in fittings

Dimensions in inches (mm)

Modular assembly

Individually wired	No. stations	Max. No. coils
2 Pin connector	2 to 20	40

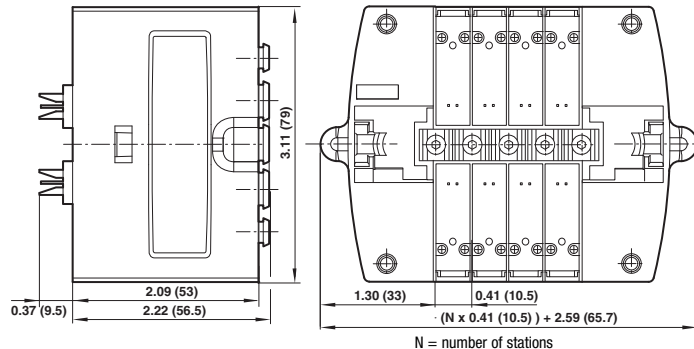

Pneumapole sub-base

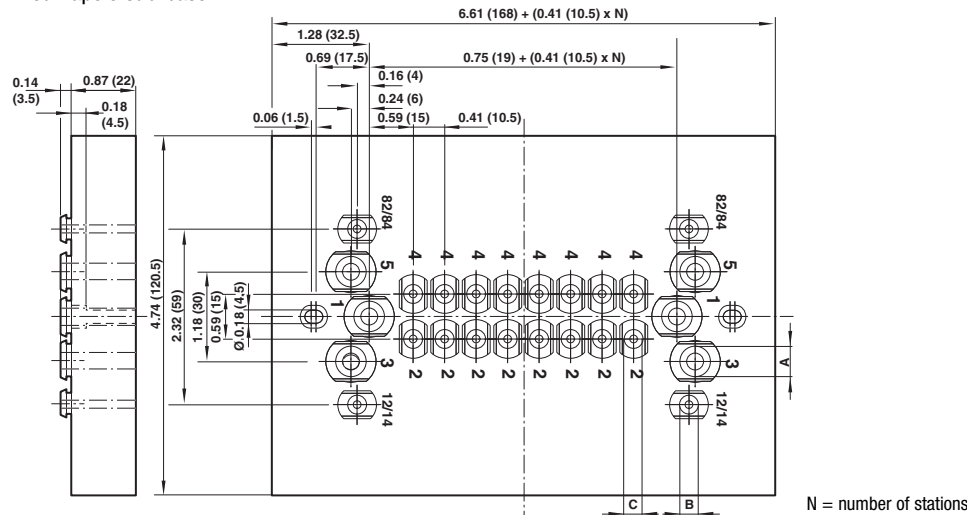

Model	Description	A, Ports 1, 3, 5	B, Ports 12/14, 82/84	C, Ports 2, 4	Exhaust type	Short code
VM106517AQ1604	4 station bottom ported Pneumapole	3/8	1/4	1/4	Standard	4C
VM106517AQ1606	6 station bottom ported Pneumapole	3/8	1/4	1/4	Standard	4F
VM106517AQ1608	8 station bottom ported Pneumapole	3/8	1/4	1/4	Standard	4J
VM106517AQ1610	10 station bottom ported Pneumapole	3/8	1/4	1/4	Standard	4C
VM106517AQ1612	12 station bottom ported Pneumapole	3/8	1/4	1/4	Standard	4F
VM106517AQ1616	16 station bottom ported Pneumapole	3/8	1/4	1/4	Standard	4J
VM106517AQ6604	4 station bottom ported Pneumapole	10 mm	6 mm	6 mm	Standard	3C
VM106517AQ6606	6 station bottom ported Pneumapole	10 mm	6 mm	6 mm	Standard	3F
VM106517AQ6608	8 station bottom ported Pneumapole	10 mm	6 mm	6 mm	Standard	3J
VM106517AQ6610	10 station bottom ported Pneumapole	10 mm	6 mm	6 mm	Standard	3C
VM106517AQ6612	12 station bottom ported Pneumapole	10 mm	6 mm	6 mm	Standard	3F
VM106517AQ6616	16 station bottom ported Pneumapole	10 mm	6 mm	6 mm	Standard	3J

Valve Manifolds, VM10 Series

Valve slices 2x3/2, 5/2, and 5/3 with integral push-in fittings

Dimensions in inches (mm)

Pneumapole sub-base – side ported

Model	Description	A Ports 1, 3 & 5	B Ports 12/14 & 82/84	C Ports 2 & 4	Exhaust type	Short code
VM106517AQ1S04	4 station Pneumapole	3/8"	1/4"	1/4"	Standard	CS04
VM106517AQ1S06	6 station Pneumapole	3/8"	1/4"	1/4"	Standard	CS06
VM106517AQ1S08	8 station Pneumapole	3/8"	1/4"	1/4"	Standard	CS08
VM106517AQ1S10	10 station Pneumapole	3/8"	1/4"	1/4"	Standard	CS10
VM106517AQ1S12	12 station Pneumapole	3/8"	1/4"	1/4"	Standard	-
VM106517AQ1S16	16 station Pneumapole	3/8"	1/4"	1/4"	Standard	-
VM106517AQ6S04	4 station Pneumapole	10 mm	6 mm	6 mm	Standard	6S04
VM106517AQ6S06	6 station Pneumapole	10 mm	6 mm	6 mm	Standard	6S06
VM106517AQ6S08	8 station Pneumapole	10 mm	6 mm	6 mm	Standard	6S08
VM106517AQ6S10	10 station Pneumapole	10 mm	6 mm	6 mm	Standard	6S10
VM106517AQ6S12	12 station Pneumapole	10 mm	6 mm	6 mm	Standard	-
VM106517AQ6S16	16 station Pneumapole	10 mm	6 mm	6 mm	Standard	-

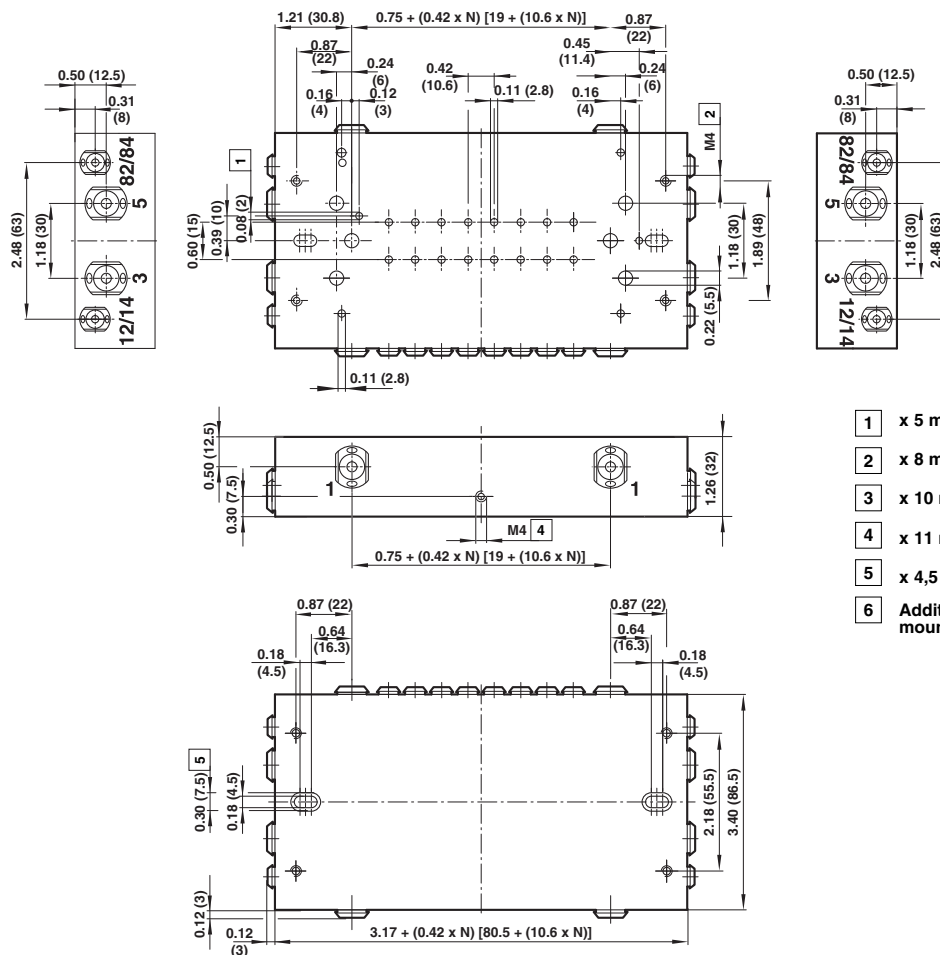

- 1 x 5 mm deep (chamfer 1x45°)
- 2 x 8 mm deep
- 3 x 10 mm deep
- 4 x 11 mm deep (12 & 16 station version only)
- 5 x 4,5 mm deep
- 6 Additional cut-out required when rear mounting 12 & 16 station versions

Panel cut-out detail

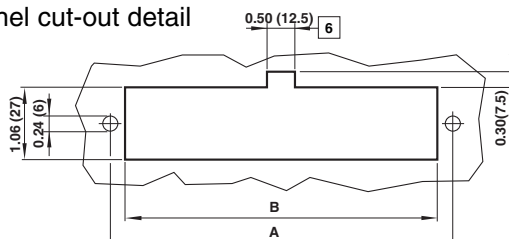

No. of stations	A	B
4	3.68 (93.50)	4.23 (107.50)
6	4.52 (114.75)	5.07 (128.75)
8	5.35 (136.00)	5.91 (150.00)
10	6.19 (157.25)	6.74 (171.25)
12	7.03 (178.50)	7.58 (192.50)
16	8.70 (221.00)	9.25 (235.00)

Valve Manifolds, VM10 Series

Valve slices 2x3/2, 5/2, and 5/3 with integral push-in fittings

Dimensions in inches (mm)

Port connections

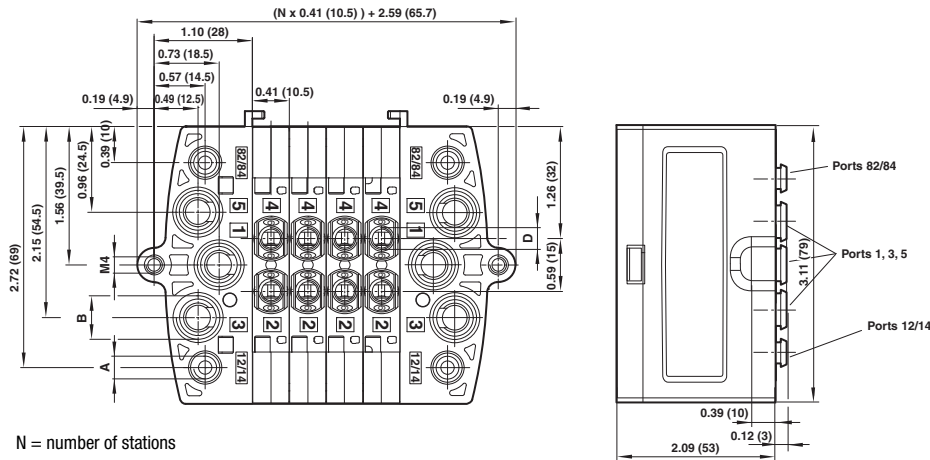

N = number of stations

End Plate Kit Model Number	Description	B Ports 1, 3, 5	A Ports 12/14 & 82/84	Short code
VM106517AQQ202	End plate kit - feed both ends	3/8"	1/4"	1G
VM106517AQQ20X	End plate kit - feed both ends	5/16"	5/32"	1H
VM106517AQQ212	End plate kit - feed left, right blocked	3/8"	1/4"	1J
VM106517AQQ21X	End plate kit - feed left, right blocked	5/16"	5/32"	1K
VM106517AQQ222	End plate kit - feed right, left blocked	3/8"	1/4"	1L
VM106517AQQ22X	End plate kit - feed right, left blocked	5/16"	5/32"	1M
VM106517AQQ10Y	End plate kit - feed both ends	10 mm	6 mm	1A
VM106517AQQ108	End plate kit - feed both ends	8 mm	4 mm	1B
VM106517AQQ11Y	End plate kit - feed left, right blocked	10 mm	6 mm	1C
VM106517AQQ118	End plate kit - feed left, right blocked	8 mm	4 mm	1D
VM106517AQQ12Y	End plate kit - feed right, left blocked	10 mm	6 mm	1E
VM106517AQQ128	End plate kit - feed right, left blocked	8 mm	4 mm	1F
VM106517AQQ131	End plate kit - feed both ends	No PIF*	No PIF*	1N
VM106517AQQ132	End plate kit - feed left, right blocked	No PIF*	No PIF*	1P
VM106517AQQ133	End plate kit - feed right, left blocked	No PIF*	No PIF*	1R

Available valve port sizes – Ø 1/8, 5/32, 1/4, 3 mm, 4 mm, 6 mm

* No push in fitting for use with pneumapole sub-base

Multipole

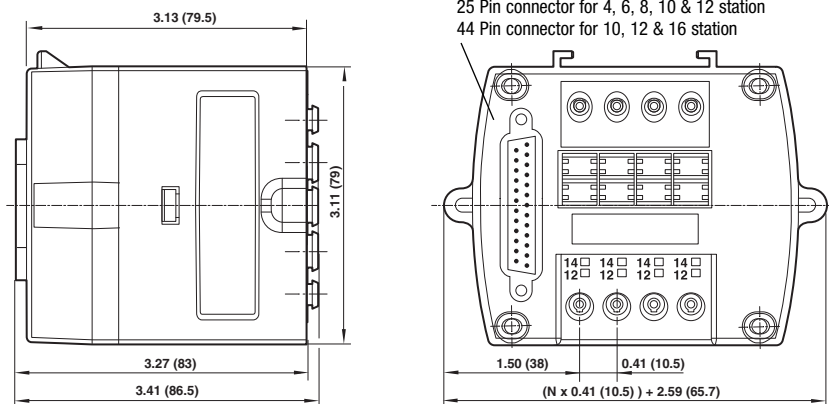

Multipole	No. stations	Model	Max. no. coils	Short code
25 Pin connector	04	VM106517AQ0404	8	A1
25 Pin connector	06	VM106517AQ0406	12	A2
25 Pin connector	08	VM106517AQ0408	16	A3
25 Pin connector	10	VM106517AQ0410	20	A4
25 Pin connector	12	VM106517AQ0412	24	A5
44 Pin connector	10	VM106517AQ0510	20	B1
44 Pin connector	12	VM106517AQ0512	24	B2
44 Pin connector	16	VM106517AQ0516	32	B3

Valve Manifolds, VM10 Series

Valve slices 2x3/2, 5/2, and 5/3 with integral push-in fittings

Single pressure

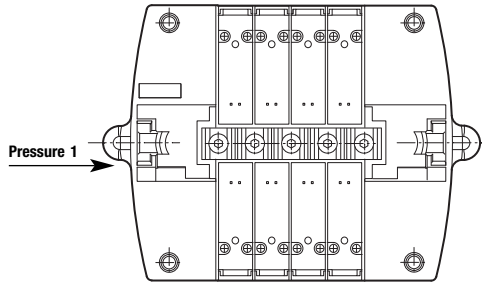

Dual pressure

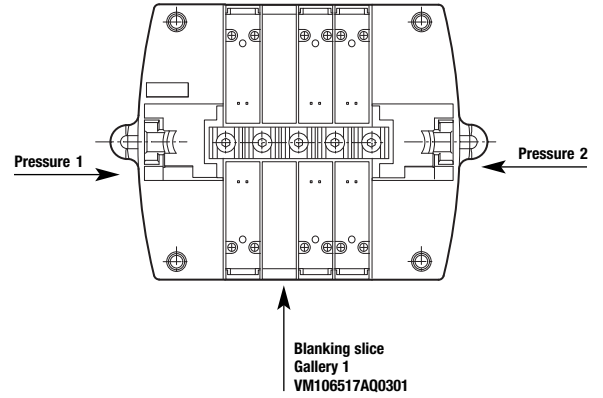

Three pressure

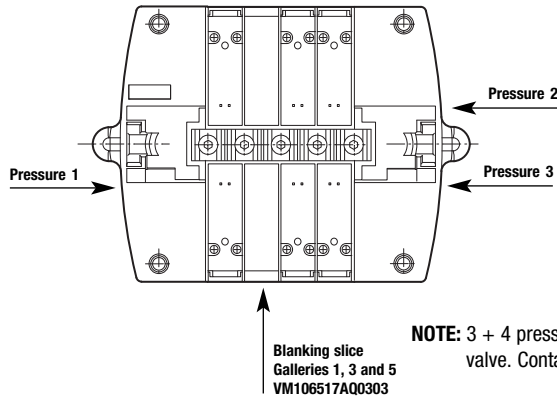

Four pressure

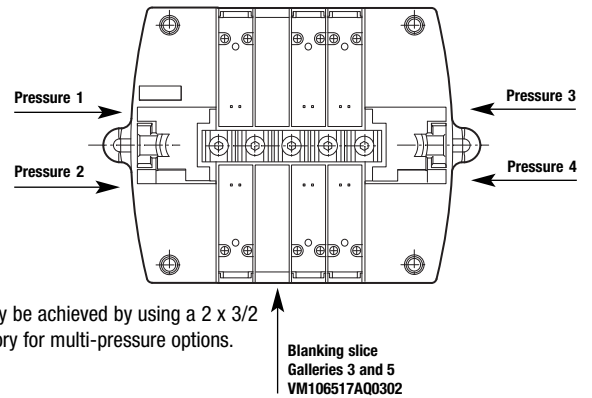

NOTE: 3 + 4 pressure can only be achieved by using a 2 x 3/2 valve. Contact the factory for multi-pressure options.

Valve Manifolds, VM10 Series

Valve slices 2x3/2, 5/2, and 5/3 with integral push-in fittings

Multi-pin connector for multi-pole

25 pin D sub-connector (IP65, NEMA 4)

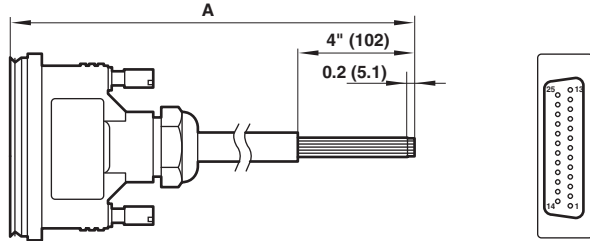

Model	A	Short code	lbs	(kg)
V11569-E01	3' (1 m)	L1	0.61	(0.276)
V11569-E03	10' (3 m)	L2	1.49	(0.676)
V11569-E05	16' (5 m)	L3	2.37	(1.076)

Pin no.	Wire color	Socket	Station
1	White	Solenoid 1-a	1
2	Brown	Solenoid 2-a	2
3	Green	Solenoid 3-a	3
4	Yellow	Solenoid 4-a	4
5	Grey	Solenoid 5-a	5
6	Pink	Solenoid 6-a	6
7	Blue	Solenoid 7-a	7
8	Red	Solenoid 8-a	8
9	Black	Solenoid 9-a	9
10	Violet	Solenoid 10-a	10
11	Grey/Pink	Solenoid 11-a	11
12	Red/Blue	Solenoid 12-a	12
13	White/Green	Common-Ve	-
14	Brown/Green	Solenoid 1-b	1
15	White/Yellow	Solenoid 2-b	2
16	Yellow/Brown	Solenoid 3-b	3
17	White/Grey	Solenoid 4-b	4
18	Grey/Brown	Solenoid 5-b	5
19	White/Pink	Solenoid 6-b	6
20	Pink/Brown	Solenoid 7-b	7
21	White/Blue	Solenoid 8-b	8
22	Brown/Blue	Solenoid 9-b	9
23	White/Red	Solenoid 10-b	10
24	Brown/Red	Solenoid 11-b	11
25	White/Black	Solenoid 12-b	12

Note: Conforms to DIN 47100

44 pin D Sub-connector (IP65, NEMA 4)

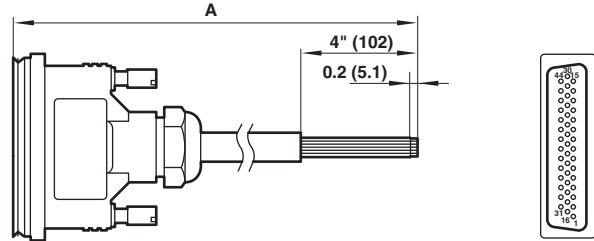











Model	A	Short code	lbs	(kg)
V11570-E01	3' (1 m)	M1	0.62	(0.280)
V11570-E03	10' (3 m)	M2	1.50	(0.680)
V11570-E05	16' (5 m)	M3	2.38	(1.080)

D-Sub connector 44-pin

Pin no.	Wire color	Socket	Pilot	Station
1	white	Solenoid 1-a	14	1
2	brown	Solenoid 2-a	14	2
3	green	Solenoid 3-a	14	3
4	yellow	Solenoid 4-a	14	4
5	grey	Solenoid 5-a	14	5
6	pink	Solenoid 6-a	14	6
7	blue	Solenoid 7-a	14	7
8	red	Solenoid 8-a	14	8
9	black	Solenoid 9-a	14	9
10	violet	Solenoid 10-a	14	10
11	grey/pink	Solenoid 11-a	14	11
12	red/blue	Solenoid 12-a	14	12
13	white/green	Solenoid 13-a	14	13
14	brown/green	Solenoid 14-a	14	14
15	white/yellow	Solenoid 15-a	14	15
16	yellow/brown	Solenoid 1-b	12	1
17	white/grey	Solenoid 2-b	12	2
18	grey/brown	Solenoid 3-b	12	3
19	white/pink	Solenoid 4-b	12	4
20	pink/brown	Solenoid 5-b	12	5
21	white/blue	Solenoid 6-b	12	6
22	brown/blue	Solenoid 7-b	12	7
23	white/red	Solenoid 8-b	12	8
24	brown/red	Solenoid 9-b	12	9
25	white/black	Solenoid 10-b	12	10
26	brown/black	Solenoid 11-b	12	11
27	grey/green	Solenoid 12-b	12	12
28	yellow/grey	Solenoid 13-b	12	13
29	pink/green	Solenoid 14-b	12	14
30	yellow/pink	Solenoid 15-b	12	15
31	green/blue	Solenoid 16-a	14	16
32	yellow/blue	Solenoid 16-b	12	16
33	-	not used	-	-
34	-	not used	-	-
35	-	not used	-	-
36	-	not used	-	-
37	-	not used	-	-
38	-	not used	-	-
39	-	not used	-	-
40	-	not used	-	-
41	-	not used	-	-
42	-	not used	-	-
43	-	Common	-	-
44	yellow/black	Common	-	-

Note: Conforms to DIN 47100

Accessories for individually wired and multipole VM10 valve manifolds

D Sub-connector 25 pin		D Sub-connector 44 pin		2 Pin connector		Valve blanking station		Port blocking station		
IP65, NEMA 4		IP65, NEMA 4		IP40, NEMA 4						
										
V11569-E01	3 ft (1m) L1	V11570-E01	3 ft (1m) M4	V11556-E03	1 ft (300mm) K1	VM106517AQ0300	2A	VM106517AQ0301	Port 1 blocked	2B
V11569-E03	10 ft (3m) L2	V11570-E03	10 ft (3m) M5	V11556-E10	3 ft (1m) K2			VM106517AQ0302	Ports 3 & 5 blocked	2C
V11569-E05	16 ft (5m) L3	V11570-E05	16 ft (5m) M6					VM106517AQ0303	Ports 1, 3 & 5 blocked	2D
Pressure switch		DIN Rail		DIN Rail fixing kit		Manual override kit		Pneumapole sub-base		
										
VM106517AQ0804	4 mm 7A	V10009-C00	3 ft (1m) A17	V11900-C01	8D	V11574-K30	Push only N1	See pages VAL-60, 61		
VM106517AQ0806	6 mm 7B					V11574-K31	Turn to lock N2			
VM106517AQ0801	1/4" 7C					V11574-K32	Push only 14 side			

Fieldbus accessories

Fieldbus power connecto					
Model	Description	Connection	Cable length	Protection class	
	V11588-E01	Profibus DP (4-pin, female) Interbus-S (4-pin, female) DeviceNet (4-pin, female) CANopen (4-pin, female)	M12	Wireable	IP65 Required for ATEX
	FD6760RS575010	Profibus DP (5-pin, female)	7/8	Wireable	IP67 when plugged and screwed down DIN VDE 0470 Required for ATEX
Communication cable and connector					
	FD6710H5S75S10	DeviceNet (5-pin, female) CANopen (5-pin, female)	M12	Wireable	IP67 when plugged and screwed down DIN VDE 0470 Required for ATEX
	FD6710D5S75S10	DeviceNet (5-pin, male) CANopen (5-pin, female)	M12	Wireable	IP67 when plugged and screwed down DIN VDE 0470 Required for ATEX
	FD6710G5S75S10	Profibus DP, reverse keyway (5-pin, female)	M12	Wireable	IP67 when plugged and screwed down DIN VDE 0470 Required for ATEX
	V11591-E01	Profibus DP, reverse keyway (5-pin, male)	M12	Wireable	IP67 when plugged and screwed down DIN VDE 0470 Required for ATEX
	V11654-E01	Profibus DP connector (9-pin, male) with terminating resistor	D-Sub	Wireable	IP40
	FD67L FD67L FD67K FD67N	DeviceNet CANopen Profibus System	M12	—	IP67 when plugged and screwed down DIN VDE 0470 Required for ATEX
	VE1ASCN1-M1200	AS-Interface power or communications (4-pin, female)	M12	Wireable	IP65 Required for ATEX
	VE2FBC9P-9S010 VE2FBC9P-9S030 VE2FBC9P-9S050	Interbus-S (9-pin)	D-Sub	1m 3m 5m	IP65 Required for ATEX
	VE2FBC9P-00000	Interbus-S (9-pin, male)	D-Sub	Wireable	IP65 Required for ATEX
	VE2FBC9S-00000	Interbus-S (9-pin, female)	D-Sub	Wireable	IP65 Required for ATEX
	V11340-E03	Interbus-S terminating connector (9-pin, male)	D-Sub	—	IP65 Required for ATEX

Valve Manifolds, VM10 Series

Valve slices 2x3/2, 5/2, and 5/3 with integral push-in fittings

Stem Silencers

Port Size	Part Number
3/8"	T45Y0006
6mm	T45P0006
5/16"/8mm	T45P0008
10mm	T45P0010

Piloting selection

Integral Pilot gasket	
Black	11540-C95
External Pilot Gasket	
Red	11540-C96

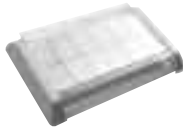

Label cover kit		
V12016-K36	4 Station	G1
V12016-K37	6 Station	G2
V12016-K38	8 Station	G3
V12016-K39	10 Station	G4
V12016-K40	12 Station	G5
V12016-K41	16 Station	G6



Labels		
V12033-L02	Write & seal label	J1
V12034-L02	Paper label	J5

Pressure switch

Model	A	Short code	lbs	(kg)
VM106517AQ0804	0.16 (4)	7A	0.009	(0.004)
VM106517AQ0806	0.24 (6)	7B	0.009	(0.004)
VM106517AQ0801	0.25 (6.5)	7C	0.009	(0.004)

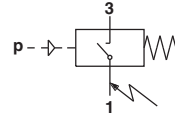

AMP E-terminals 2.8 x 0.8
 Degree of protection: NEMA 1, IP00
 Non adjustable
 Pressure range: 0 to 145 psig (0 to 10 bar)
 Switching point rising pressure: 4 to 73 psig (3 to 5 bar)
 Switch point falling pressure: 36 to 54 psig (2.5 to 3.7 bar)

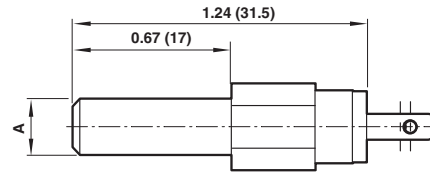

NOTE: Use Pneufit C composite plugs where needed. Do not use nickel plated brass plugs.

Fieldbus connections (M12 connector types)

Standard fieldbus - available protocols	No. stations	Node part numbers	Max. No. coils	Short code
DeviceNet	08	VM10DNFNB-00082	16	C1
DeviceNet	10	VM10DNFNB-00102	20	C2
DeviceNet	12	VM10DNFNB-00122	24	C3
DeviceNet	16	VM10DNFNB-00162	32	C4
CANopen	08	VM10CAFNB-00082	16	D1
CANopen	10	VM10CAFNB-00102	20	D2
CANopen	12	VM10CAFNB-00122	24	D3
CANopen	16	VM10CAFNB-00162	32	D4
AS - interface*	04	VM10AS10A-00410**	4	J1
AS - interface*	08	VM10AS10A-00810**	8	J2
AS - interface*	04	VM10AS10A-00820**	8	J3
AS - interface*	06	VM10AS10A-00830**	8	J4
AB RIO	08	VM10RIFNB-00080	16	G1
AB RIO	10	VM10RIFNB-00100	20	G2
AB RIO	12	VM10RIFNB-00120	24	G3
AB RIO	16	VM10RIFNB-00160	32	G4

* Use 2 x M12 protocol connectors

**Node part number = 410 (4 x sol/spring), 810 (8 x sol/spring), 820 (4 x sol/sol), 830 (4 x sol/spring, 2 x sol/sol)

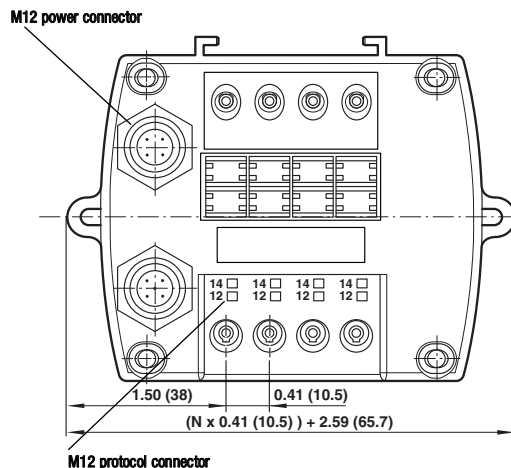
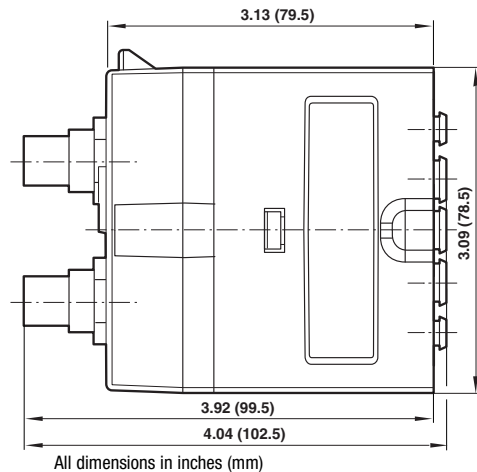

Valve Manifolds, VM10 Series

Valve slices 2x3/2, 5/2, and 5/3 with integral push-in fittings

Fieldbus connections with (M12 connector types)

Standard fieldbus - available protocols	No. stations	Node part numbers	Max. no. coils	Short code
Profibus-DP	08	VM10DPFNB-00080	16	E1
Profibus-DP	10	VM10DPFNB-00100	20	E2
Profibus-DP	12	VM10DPFNB-00120	24	E3
Profibus-DP	16	VM10DPFNB-00160	32	E4

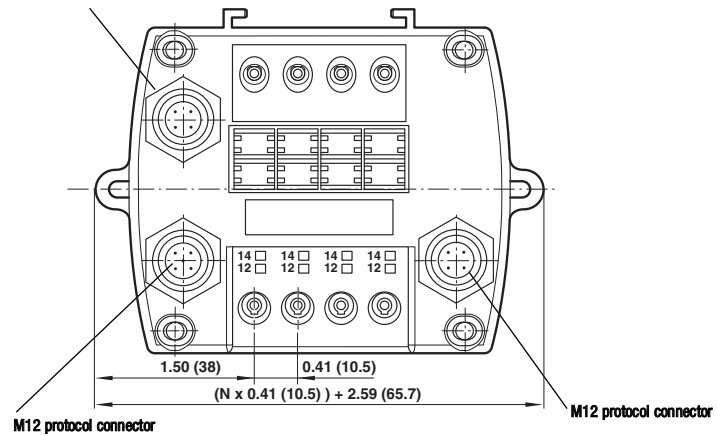
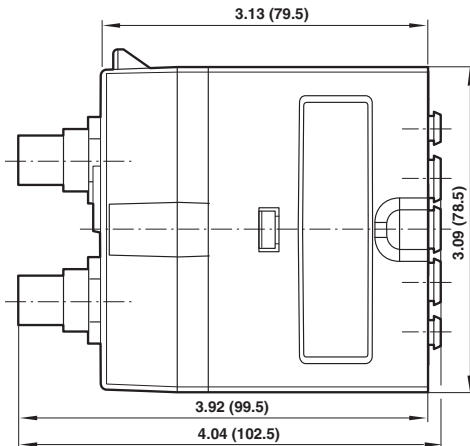

Fieldbus connections - (9 pin D-type connector)

Standard fieldbus - available protocols	No. stations	Node part numbers	Max. no. coils	Short code
Interbus-S	08	VM10IBFNB-00080	16	F1
Interbus-S	10	VM10IBFNB-00100	20	F2
Interbus-S	12	VM10IBFNB-00120	24	F3
Interbus-S	16	VM10IBFNB-00160	32	F4

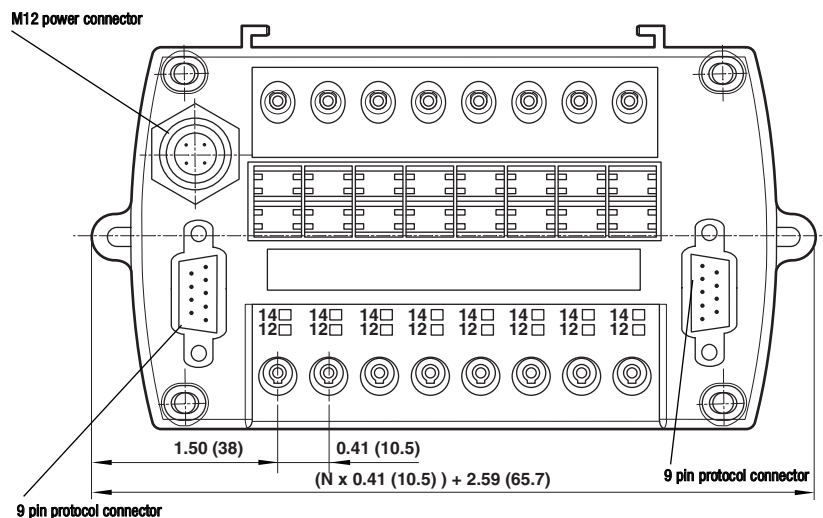
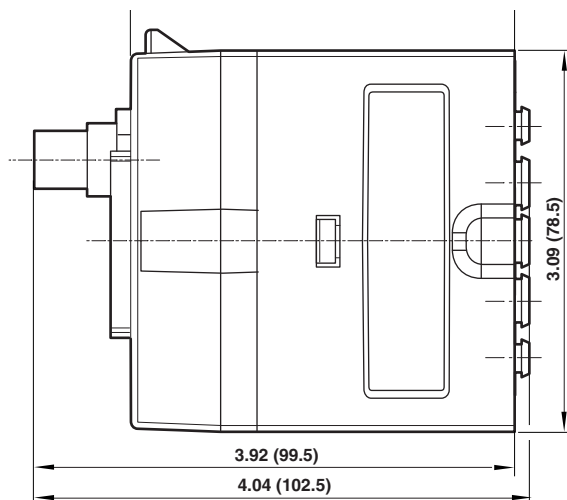

All dimensions in inches (mm)