

Light weight fittings for Rail Industry
Metric
Ø 6 to 42 mm
BSPP & BSPT Thread

For use in areas of vibration

Pre-assembled units

No special assembly tools or heat required

Can be remade without damage to tube

Suitable for use on seam welded as well as seamless tube or pipe

Thinner tube can be used; as thin as 0,8 mm wall thickness

Lower torque requirement on the tube nut than fittings which bite into the tube

Will cope with tube misalignment of +/-4°

Corrosion resistant AL2 alloy

Approximately 65% lighter than brass or stainless steel fittings

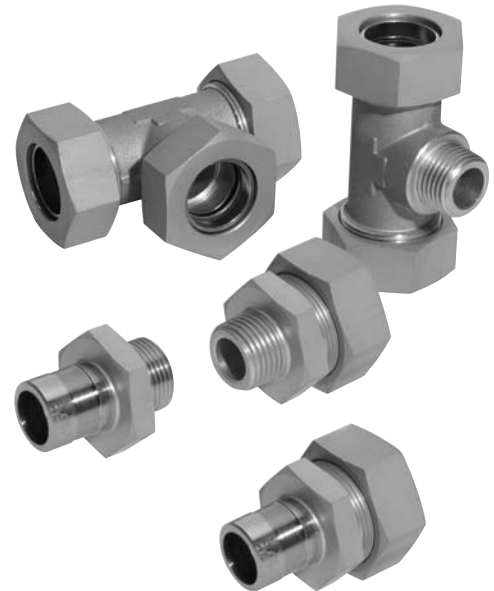

Technical data

Medium:

Compressed air, water (plus other media suitable for use with materials of construction).

Operating pressure:

Typically up to 15 bar for Rail applications

For applications above 15 bar contact Norgren technical service

Ambient temperature:

-45°C to +150°C with HNBR 'O' ring (yellow)

-30°C to +200°C with FKM 'O' ring (optional)

Tube sizes:

6, 8, 10, 12, 14, 15, 18, 20, 22, 25, 28, 32, 35, 38, 42 mm

Thread sizes:

1/8", 1/4", 3/8", 1/2", 3/4", 1", 1 1/2" (BSPT and BSPP)

Tubing:

Designed for use with:

Copper tube to BS 2871

Stainless Steel tube to AISI 304 and AISI 316

Nylon - PA12 (tube support required)

Testing & Approvals:

PED 97/23/EC

Shock & Vibration tested to EN 61373 Category 2 - (Bogie mounted)

Salt Spray tested to ISO 9227-06, data on request

Materials

Body & Nut: AL2 Aluminium with PA20 anodic treatment to HB 175 hardness

Washer & Clampring: Brass, white galvanised

'O'-Ring: HNBR - colour coded yellow

Ordering information

see page 2

Method of assembly

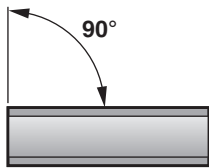

1. Ensure that the end of the tube is cut square and is free from burrs.

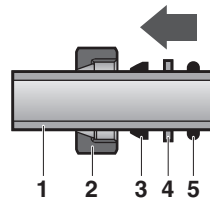

2. Slide the nut (2) onto the pipe (1) from right to left. Slide the split ring (3) onto the pipe (1) from right to left keeping the smaller edge towards the nut (2). Slide the washer (4) onto the pipe (1) from right to left. Slide the O-ring (5) onto the pipe (1) from right to left. N.B. The pipe head must be deburred to ensure the O ring is not damaged.

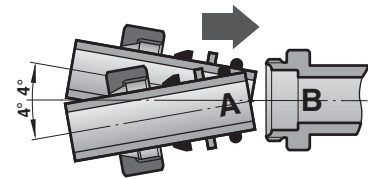

3. Before installing the pipe fittings, check that the pipes misalignment is not higher than $\pm 4^\circ$

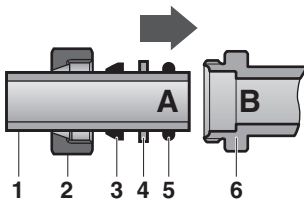

4. Move the pipe head (A) with all components assembled as shown towards the casing abutment (B). In pipe fittings without abutment (B), the pipe should be inserted as per the tube stop/abutment position listed below.

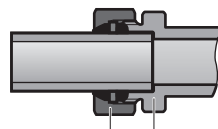

5. Move the four components from left to right and screw the nut (2) onto the pipe fitting casing (6).

Options selector

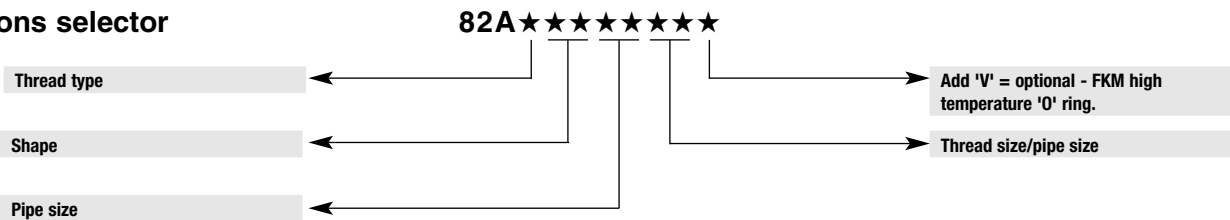

Recommended nut torque settings

Torque settings based on Railway applications up to 15 bar for use with stainless steel tube

Tube Ø mm	Recommended torque	Tube Ø mm	Recommended torque
6	20 Nm	22	55 Nm
8	20 Nm	25	75 Nm
10	20 Nm	28	95 Nm
12	25 Nm	30	135 Nm
14	30 Nm	32	150 Nm
15	30 Nm	35	170 Nm
16	35 Nm	38	280 Nm
18	45 Nm	42	290 Nm
20	55 Nm		



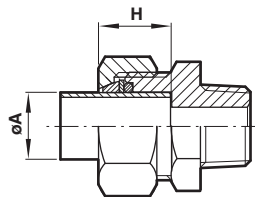





Tube stop position







Ø A	H	Ø A	H
6	16,0	22	19,5
8	17,0	25	21,0
10	18,5	28	22,5
12	18,0	30	23,0
14	18,0	32	23,5
15	18,5	35	23,5
16	20,5	38	27,0
18	19,5	42	26,5
20	19,5		

The information provided in this table are typical values as dimension H will vary slightly with torque applied to the nut. For fittings without tube stops such as straight connector and bulkheads the above tube insertion depths are also applicable





Straight adaptors and connectors

<p>Straight adaptor (taper) 82A125</p>  <p>Page 4</p>	<p>Straight adaptor (parallel) 82A225</p>  <p>Page 4</p>	<p>Female adaptor (parallel) 82A226</p>  <p>Page 5</p>	<p>Straight union (equal) 82A020</p>  <p>Page 5</p>	<p>Straight union (unequal) 82A020</p>  <p>Page 6</p>	<p>Bulkhead union 82A029</p>  <p>Page 6</p>	<p>Cap 82A012</p>  <p>Page 6</p>
<p>Straight stem connector (taper) 82A115</p>  <p>Page 7</p>	<p>Straight stem connector (parallel) 82A215</p>  <p>Page 8</p>					

Elbow connectors and adaptors

<p>Union elbow (equal) 82A040</p>  <p>Page 9</p>	<p>Union elbow (unequal) 82A040</p>  <p>Page 9</p>	<p>90° Elbow adaptor (taper) 82A145</p>  <p>Page 10</p>	<p>90° Elbow adaptor female (taper) 82A246</p>  <p>Page 10</p>
--	--	---	--

Tee connectors and adaptors

<p>Union tee (equal) 82A060</p>  <p>Page 11</p>	<p>Union tee (unequal) 82A060</p>  <p>Page 11</p>	<p>Tee adaptor (taper) 82A165</p>  <p>Page 12</p>	<p>Tee adaptor female (parallel) 82A266</p>  <p>Page 12</p>
---	---	---	---

Accessories

<p>Tubing nut 82A0F4</p>  <p>Page 13</p>	<p>Split ring 82A0J1</p>  <p>Page 13</p>	<p>Tubing washer 82A0E7</p>  <p>Page 13</p>	<p>Tubing 'O'-Ring 8000K</p>  <p>Page 13</p>	<p>Thread 'O' ring (parallel thread) 8000K</p>  <p>Page 13</p>
--	--	---	--	---

82A125

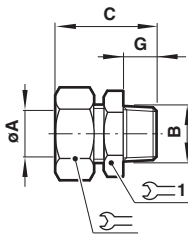

Straight adaptor

Ø A	B	C	G	≡	≡ 1	Model
6	R1/8	33,5	10	19	16	82A1250618
6	R1/4	35,5	12	19	16	82A1250628
6	R3/8	35,5	12	19	18	82A1250638
8	R1/8	35	10	21	17	82A1250818
8	R1/4	37	12	21	17	82A1250828
8	R3/8	37	12	21	18	82A1250838
10	R1/8	35,5	10	24	19	82A1251018
10	R1/4	37,5	12	24	19	82A1251028
10	R3/8	37,5	12	24	19	82A1251038
12	R1/4	39,5	12	26	23	82A1251228
12	R3/8	39,5	12	26	23	82A1251238
14	R1/4	42	12	28	25	82A1251428
14	R3/8	42	12	28	25	82A1251438
14	R1/2	43	13	28	25	82A1251448
15	R1/4	39	12	30	25	82A1251528
15	R3/8	39	12	30	25	82A1251538
15	R1/2	40	13	30	25	82A1251540
16	R1/4	39	12	30	27	82A1251628
16	R3/8	39	12	30	27	82A1251638
16	R1/2	40	13	30	27	82A1251648
18	R3/8	41	12	32	18	82A1251838
18	R1/2	42	13	32	18	82A1251848
18	R3/4	44	15	32	18	82A1251868
20	R3/8	41,5	12	34	30	82A1252038
20	R1/2	42,5	13	34	30	82A1252048
20	R3/4	44,5	15	34	30	82A1252068
22	R1/2	43	13	38	34	82A1252248
22	R3/4	45	15	38	34	82A1252268
25	R1/2	44	13	45	38	82A1252548
25	R3/4	46	15	45	40	82A1252568
25	R1	49	18	45	38	82A1252588
28	R1/2	45,5	13	45	40	82A1252848
28	R3/4	47,5	15	45	40	82A1252868
28	R1	50,5	18	45	40	82A1252888
30	R3/4	48,5	13	50	45	82A1253068
30	R1	51,5	15	50	45	82A1253088
32	R3/4	49	18	50	46	82A1253268
32	R1	52	15	50	45	82A1253288
32	R1 1/4	52	18	50	45	82A12532A8
35	R3/4	49	18	55	50	82A1253568
35	R1	52	13	55	50	82A1253588
35	R1 1/4	52	15	55	50	82A12535A8
38	R3/4	52	18	60	50	82A1253868
38	R1	55	15	60	50	82A1253888
38	R1 1/4	55	18	60	50	82A12538A8
42	R1	54	18	70	60	82A1254288
42	R1 1/4	54	18	70	60	82A12542A8
42	R1 1/2	56	20	70	60	82A12542B8
42	R2	56	20	70	60	82A12542C8

82A225

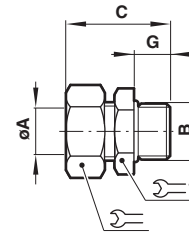

Straight adaptor

Ø A	B	C	G	≡	≡ 1	Model
6	G1/8	30	6	19	18	82A2250618
6	G1/4	33	8	19	22	82A2250628
6	G3/8	33	8	19	24	82A2250638
8	G1/8	31	6	21	18	82A2250818
8	G1/4	33	8	21	22	82A2250828
8	G3/8	33	8	21	24	82A2250838
10	G1/8	31	6	24	18	82A2251018
10	G1/4	34	8	24	22	82A2251028
10	G3/8	34	8	24	24	82A2251038
12	G1/8	33	6	26	21	82A2251218
12	G1/4	35	8	26	22	82A2251228
12	G3/8	35	8	26	24	82A2251238
14	G1/4	37	8	28	23	82A2251428
14	G3/8	37	8	28	24	82A2251438
14	G1/2	41	10	28	32	82A2251448
15	G1/4	34	8	30	24	82A2251528
15	G3/8	34	8	30	24	82A2251538
15	G1/2	38	10	30	32	82A2251548
16	G1/4	24	14	30	24	82A2251628
16	G3/8	25	8	30	25	82A2251638
16	G1/2	32	8	30	32	82A2251648
18	G3/8	28	8	32	28	82A2251838
18	G1/2	32	10	32	32	82A2251848
18	G3/4	36	10	32	38	82A2251868
20	G3/8	36,5	8	34	28	82A2252038
20	G1/2	40,5	10	34	32	82A2252048
20	G3/4	46,5	14	34	38	82A2252068
22	G1/2	40,5	10	38	34	82A2252248
22	G3/4	46,5	14	38	38	82A2252268
25	G1/2	46,5	10	45	38	82A2252548
25	G3/4	48	14	45	38	82A2252568
25	G1	48	14	45	45	82A2252588
28	G1/2	41,5	10	45	38	82A2252848
28	G3/4	47,5	14	45	38	82A2252868
28	G1	47,5	14	45	45	82A2252888
30	G3/4	47,5	14	50	42	82A2253068
30	G1	47,5	14	50	45	82A2253088
32	G3/4	48	14	50	45	82A2253268
32	G1	48	14	50	45	82A2253288
32	G1 1/4	50	16	50	60	82A22532A8
35	G3/4	46	14	55	45	82A2253568
35	G1	49	14	55	45	82A2253588
35	G1 1/4	51	16	55	60	82A22535A8
38	G3/4	48	14	60	50	82A2253868
38	G1	50	14	60	50	82A2253888
38	G1 1/4	57	16	60	60	82A22538A8
42	G1	49	14	70	60	82A2254288
42	G1 1/4	56	16	70	60	82A22542A8
42	G1 1/2	56	16	70	70	82A22542B8
42	G2	58	18	70	80	82A22542C8

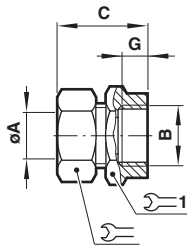
82A226

Female adaptor

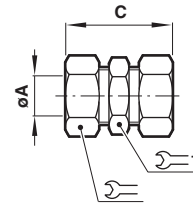
Ø A	B	C	G	1	1	Model
6	G1/8	31	11	19	18	82A2260618
6	G1/4	32	12	19	22	82A2260628
8	G1/8	30,5	11	21	18	82A2260818
8	G1/4	32,5	12	21	22	82A2260828
8	G3/8	33,5		21	25	82A2260838
10	G1/8	32,5	11	24	18	82A2261018
10	G1/4	33,5	12	24	22	82A2261028
10	G3/8	35	12,5	24	25	82A2261038
10	G1/2	34,5	13	24	30	82A2261048
12	G1/4	33,8	12	26	22	82A2261228
12	G3/8	33,8	12,5	26	25	82A2261238
12	G1/2	34,8	13	26	30	82A2261248
14	G1/4	32,8	12	28	23	82A2261428
14	G3/8	34,8	12,5	28	25	82A2261438
14	G1/2	35,8	13	28	30	82A2261448
15	G1/4	32,8	12	30	25	82A2261528
15	G3/8	34,8	12,5	30	25	82A2261538
15	G1/2	34,8	13	30	30	82A2261548
16	G3/8	34	12,5	30	26	82A2261638
16	G1/2	35	13	30	30	82A2261648
18	G3/8	34	12,5	32	27	82A2261838
18	G1/2	37	13	32	30	82A2261848
18	G3/4	38	15	32	38	82A2261868
20	G3/8	34,5	12,5	34	30	82A2262038
20	G1/2	35,5	13	34	30	82A2262048
20	G3/4	38,5	15	34	38	82A2262068
22	G3/8	34,5	12,5	38	34	82A2262238
22	G1/2	35,5	13	38	34	82A2262248
22	G3/4	38,5	15	38	38	82A2262268
25	G1/2	37	13	45	38	82A2262548
25	G3/4	39	15	45	38	82A2262568
25	G1	43	18	45	50	82A2262588
28	G3/4	40	15	45	38	82A2262868
28	G1	47	18	45	50	82A2262888
30	G3/4	41	15	50	45	82A2263068
30	G1	40	18	50	45	82A2263088
30	G1 1/4	45	20	50	60	82A22630A8
32	G3/4	41	15	50	45	82A2263268
32	G1	43	18	50	50	82A2263288
32	G1 1/4	45	20	50	60	82A22632A8
35	G3/4	43,5	15	55	50	82A2263568
35	G1	43,5	18	55	50	82A2263588
35	G1 1/4	43,5	20	55	60	82A22635A8
38	G1	44,5	18	60	50	82A2263888
38	G1 1/4	48,5	20	60	60	82A22638A8
38	G1 1/2	48,5	20	60	70	82A22638B8
42	G1	45	18	70	60	82A2264288
42	G1 1/4	48	20	70	60	82A22642A8
42	G1 1/2	49	20	70	70	82A22642B8

82A020

Straight union (equal)

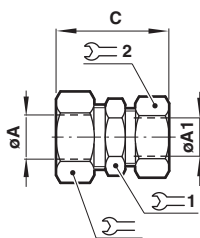
Ø A	C	1	1	Model
6	41	19	15	82A0200600
8	43,5	21	18	82A0200800
10	45	24	20	82A0201000
12	46	26	23	82A0201200
14	46	28	25	82A0201400
15	47	30	25	82A0201500
16	48	30	27	82A0201600
18	50	32	28	82A0201800
20	49	34	30	82A0202000
22	49	38	34	82A0202200
25	51	45	38	82A0202500
28	54	45	40	82A0202800
30	56	50	45	82A0203000
32	56	50	45	82A0203200
35	57	55	50	82A0203500
38	61	60	50	82A0203800
42	62	70	60	82A0204200

82A020



Straight union (unequal)

Ø A	Ø A1	C	1	1	2	Model
8	6	35	21	17	19	82A0200806
10	6	39	24	19	19	82A0201006
10	8	39	24	19	21	82A0201008
12	8	41,5	26	23	21	82A0201208
12	10	41,5	26	23	24	82A0201210
14	10	44	28	24	24	82A0201410
14	12	44	28	24	26	82A0201412
15	10	46	30	25	24	82A0201510
15	12	46	30	25	26	82A0201512
15	14	46	30	25	28	82A0201514
16	10	46	30	26	26	82A0201610
16	14	46	30	26	28	82A0201614
18	14	48	32	28	28	82A0201814
18	15	48	32	28	30	82A0201815
18	16	48	32	28	30	82A0201816
20	15	50	34	30	28	82A0202015
20	16	50	34	30	30	82A0202016
20	18	50	34	30	32	82A0202018
22	18	54	38	34	32	82A0202218
22	20	54	38	34	34	82A0202220
25	18	62	45	38	32	82A0202518
25	20	62	45	38	34	82A0202520
25	22	62	45	38	38	82A0202522
28	20	62,5	45	40	34	82A0202820
28	22	62,5	45	40	38	82A0202822
28	28	62,5	45	40	45	82A0202828
30	22	67,5	50	45	38	82A0203022
30	25	67,5	50	45	45	82A0203025
30	28	67,5	50	45	45	82A0203028
32	25	67,5	50	45	45	82A0203225
32	28	67,5	50	45	45	82A0203228
32	30	67,5	50	45	50	82A0203230
35	28	73	55	50	45	82A0203528
35	30	73	55	50	50	82A0203530
35	32	73	55	50	50	82A0203532
38	30	80	60	50	50	82A0203830
38	32	80	60	50	50	82A0203832
38	35	80	60	50	55	82A0203835
42	35	90,5	70	60	55	82A0204235
42	38	90,5	70	60	60	82A0204238

82A029

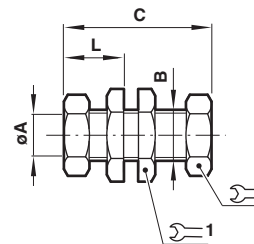

Bulkhead union

Ø A	Ø B	C	L	1	1	Model
6	15	57	23	19	19	82A0290600
8	17	59	25	21	21	82A0290800
10	19	60	25,5	24	23	82A0291000
12	22	63	27	26	27	82A0291200
14	24	70,6	29	28	30	82A0291400
15	25	65,8	27	30	30	82A0291500
16	26	65	28	30	32	82A0291600
18	28	65	29	32	34	82A0291800
20	30	69,5	29,5	34	38	82A0292000
22	34	71	29,5	38	40	82A0292200
25	37	75	31	45	45	82A0292500
28	39	70,5	30	45	45	82A0292800
30	43	77,5	33	50	50	82A0293000
32	45	77	33	50	50	82A0293200
35	47	83	35	55	55	82A0293500
38	50	84	36	60	60	82A0293800
42	59	84	235	70	70	82A0294200

82A012

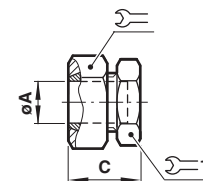

Cap

Ø A	C	1	1	Model
6	23	19	16	82A0120600
8	23,5	21	17	82A0120800
10	25	24	19	82A0121000
12	27	26	23	82A0121200
14	28	28	24	82A0121400
15	26	30	24	82A0121500
16	27	30	27	82A0121600
18	29	32	28	82A0121800
20	29,5	34	30	82A0122000
22	29,5	38	34	82A0122200
25	31	45	38	82A0122500
28	31,5	45	40	82A0122800
30	32,5	50	45	82A0123000
32	33	50	45	82A0123200
35	34	55	50	82A0123500
38	36	60	50	82A0123800
42	34	70	60	82A0124200

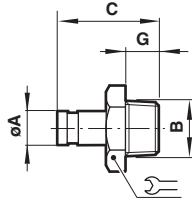
82A115

Straight stem connector

Ø A	C	C	G	≡	Model
6	R1/8	32	10	12	82A1150618
6	R1/4	34	12	14	82A1150628
6	R3/8	34	12	18	82A1150638
8	R1/8	34,5	10	12	82A1150818
8	R1/4	35,5	12	14	82A1150828
8	R3/8	35,5	12	18	82A1150838
8	R1/2	36,5	13	22	82A1150848
10	R1/8	34,5	10	12	82A1151018
10	R1/4	36,5	12	14	82A1151028
10	R3/8	36,5	12	18	82A1151038
10	R1/2	37,5	13	22	82A1151048
10	R3/4	41,5	15	28	82A1151068
12	R1/4	37,5	12	14	82A1151228
12	R3/8	37,5	12	18	82A1151238
12	R1/2	38,5	13	22	82A1151248
12	R3/4	41,5	15	28	82A1151268
14	R1/4	38	12	15	82A1151428
14	R3/8	38	12	18	82A1151438
14	R1/2	39	13	22	82A1151448
14	R3/4	42	15	28	82A1151468
15	R3/8	38	12	18	82A1151538
15	R1/2	39	13	22	82A1151548
15	R3/4	42	15	28	82A1151568
16	R1/4	39	12	18	82A1151628
16	R3/8	39	12	18	82A1151638
16	R1/2	40	13	22	82A1151648
16	R3/4	43	15	28	82A1151668
16	R1	46	18	34	82A1151688
18	R1/4	40	12	19	82A1151828
18	R3/8	40	12	19	82A1151838
18	R1/2	41	13	22	82A1151848
18	R3/4	44	15	28	82A1151868
18	R1	47	18	34	82A1151888
20	R1/4	41	12	21	82A1152028
20	R3/8	41	12	21	82A1152038
20	R1/2	42	13	21	82A1152048
20	R3/4	44,5	15	28	82A1152068
20	R1	47	18	34	82A1152088
22	R3/8	41,5	12	23	82A1152238
22	R1/2	42,5	13	23	82A1152248
22	R3/4	44,5	15	28	82A1152268
22	R1	47,5	18	34	82A1152288
25	R3/8	43	12	27	82A1152538
25	R1/2	44	13	27	82A1152548
25	R3/4	46	15	28	82A1152568
25	R1	49	18	34	82A1152588
25	R1 1/4	49	18	45	82A11525A8

Ø A	C	C	G	≡	Model
28	R1/2	45	13	30	82A1152848
28	R3/4	47	15	30	82A1152868
28	R1	50	18	34	82A1152888
28	R1 1/4	50	18	45	82A11528A8
30	R3/4	48,5	15	32	82A1153068
30	R1	51,5	18	34	82A1153088
30	R1 1/4	51,5	18	45	82A11530A8
30	R1 1/2	53,5	20	50	82A11530B8
32	R3/4	48,5	15	34	82A1153268
32	R1	51,5	18	34	82A1153288
32	R1 1/4	51,5	18	45	82A11532A8
35	R1	53	18	38	82A1153588
35	R1 1/4	53	18	45	82A11535A8
35	R1 1/2	55	20	50	82A11535B8
38	R1	55	18	40	82A1153888
38	R1 1/4	55	18	45	82A11538A8
38	R1 1/2	57	20	50	82A11538B8
42	R1	56,5	18	45	82A1154288
42	R1 1/4	56,5	18	45	82A11542A8
42	R1 1/2	58,5	20	50	82A11542B8

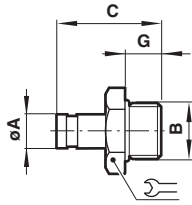
82A215



Straight stem connector

Ø A	B	C	G	⌀	Model
6	G1/8	29	6	18	82A2150618
6	G1/4	32	8	22	82A2150628
6	G3/8	32	8	24	82A2150638
8	G1/8	32,5	6	18	82A2150818
8	G1/4	29,5	8	22	82A2150828
8	G3/8	32,5	8	24	82A2150838
8	G1/2	36,5	10	32	82A2150848
10	G1/8	30,5	6	18	82A2151018
10	G1/4	33,5	8	22	82A2151028
10	G3/8	33,5	8	24	82A2151038
10	G1/2	37,5	10	32	82A2151048
12	G3/8	33,5	8	24	82A2151238
12	G1/2	37,5	10	32	82A2151248
12	G3/4	41,5	14	38	82A2151268
14	G1/4	34	8	22	82A2151428
14	G3/8	34	8	24	82A2151438
14	G1/2	38	10	32	82A2151448
14	G3/4	42	14	38	82A2151468
15	G3/8	34	8	24	82A2151538
15	G1/2	38	10	32	82A2151548
15	G3/4	42	14	38	82A2151568
16	G1/4	35	8	22	82A2151628
16	G3/8	35	8	24	82A2151638
16	G1/2	39	10	32	82A2151648
16	G3/4	43	14	38	82A2151668
16	G1	45	14	50	82A2151688
18	G1/4	35	8	22	82A2151828
18	G3/8	35	8	24	82A2151838
18	G1/2	40	10	32	82A2151848
18	G3/4	44	14	38	82A2151868
18	G1	45	14	50	82A2151888
20	G1/4	36	8	22	82A2152028
20	G3/8	36	8	24	82A2152038
20	G1/2	40	10	32	82A2152048
20	G3/4	44	14	38	82A2152068
20	G1	46	14	50	82A2152088
22	G3/8	36,5	8	24	82A2152238
22	G1/2	40,5	10	32	82A2152248
22	G3/4	44,5	14	38	82A2152268
22	G1	46	14	50	82A2152288
25	G3/8	38	8	26	82A2152538
25	G1/2	42	10	32	82A2152548
25	G3/4	46	14	38	82A2152568
25	G1	45	14	50	82A2152588
25	G1 1/4	49	16	60	82A21525A8

Ø A	B	C	G	⌀	Model
28	G3/4	46	14	38	82A2152868
28	G1	48	14	50	82A2152888
28	G1 1/4	52	16	60	82A21528A8
30	G3/4	46,5	14	38	82A2153068
30	G1	48,5	14	50	82A2153088
30	G1 1/4	52,5	16	60	82A21530A8
30	G1 1/2	55,5	18	70	82A21530B8
32	G3/4	46,5	14	38	82A2153268
32	G1	48,5	14	50	82A2153288
32	G1 1/4	55,5	16	60	82A21532A8
35	G1	50	14	50	82A2153588
35	G1 1/4	57	16	60	82A21535A8
35	G1 1/2	57	18	70	82A21535B8
38	G1	52	14	50	82A2153888
38	G1 1/4	59	16	60	82A21538A8
38	G1 1/2	59	18	70	82A21538B8
42	G1	53,5	14	50	82A2154288
42	G1 1/4	60,5	16	60	82A21542A8
42	G1 1/2	60,5	18	70	82A21542B8

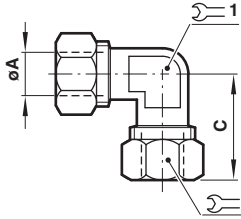
82A040

Union elbow (equal)

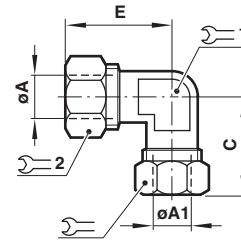
$\varnothing A$	C	\varnothing	$\varnothing 1$	Model
6	28	19	12	82A0400600
8	31,5	21	14	82A0400800
10	33,5	24	14	82A0401000
12	36	26	16	82A0401200
14	36,5	28	18	82A0401400
15	36	30	20	82A0401500
16	38	30	20	82A0401600
18	39	32	22	82A0401800
20	40	34	25	82A0402000
22	39	38	27	82A0402200
25	42	45	32	82A0402500
28	46	45	33	82A0402800
30	50	50	36	82A0403000
32	52	50	40	82A0403200
35	51,5	55	40	82A0403500
38	58,5	60	50	82A0403800
42	59	70	50	82A0404200

82A040

Union elbow (unequal)

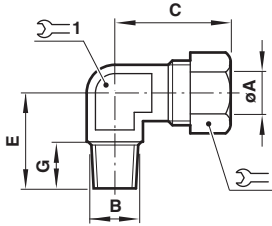
$\varnothing A$	$\varnothing A1$	C	E	\varnothing	$\varnothing 1$	$\varnothing 2$	Model
8	6	32	32	19	14	21	82A0400806
10	6	32,5	29,5	19	14	24	82A0401006
10	8	32,5	32,53	21	14	24	82A0401008
12	6	35	36,8	19	16	26	82A0401206
12	10	35,5	36,8	24	16	26	82A0401210
14	6	35,5	37,3	19	18	28	82A0401406
14	8	35,5	39,3	21	18	28	82A0401408
14	10	35,5	39,3	24	18	28	82A0401410
14	12	36,3	36,8	26	18	28	82A0401412
16	10	36,5	38	24	20	30	82A0401610
16	12	36,8	37,5	26	20	30	82A0401612
18	8	37	39	21	20	32	82A0401808
18	10	36,5	39	24	20	32	82A0401810
18	12	37,3	39	26	20	32	82A0401812
18	14	40,3	39	28	22	32	82A0401814
18	16	37,5	39	30	27	32	82A0401816
20	12	40,8	39,5	26	27	34	82A0402012
20	14	39,8	42	28	27	34	82A0402014
20	16	39	39,5	30	27	34	82A0402016
20	18	40	40	32	29	34	82A0402018
22	16	39	40	30	29	34	82A0402216
22	18	40	42	32	32	38	82A0402218
25	18	43	43,5	32	32	38	82A0402518
25	20	42,5	42,3	34	32	45	82A0402520
25	22	43	44	38	32	45	82A0402522
28	20	42,5	41,5	34	32	45	82A0402820
28	25	45	41,5	45	36	45	82A0402825
30	18	51	50,5	32	36	45	82A0403018
30	20	48,5	50,5	34	36	50	82A0403020
30	22	49	49	38	38	50	82A0403022
30	25	54,5	50,5	45	38	50	82A0403025
30	28	50,5	49	45	40	50	82A0403028
32	20	50,5	49	34	40	50	82A0403220
32	22	51,5	51,5	38	40	50	82A0403222
32	25	53,5	49	45	40	50	82A0403225
32	28	52,5	49	45	40	50	82A0403228
35	20	50,5	51,5	34	40	55	82A0403520
35	22	51	51,5	38	40	55	82A0403522
35	25	53,5	51,5	45	40	55	82A0403525
35	28	52,5	51,5	45	50	55	82A0403528
38	22	56	53,5	38	50	60	82A0403822
38	25	59	53,5	45	50	60	82A0403825
38	30	57	59	50	50	60	82A0403830
38	23	58,5	60,5	50	50	60	82A0403832
42	25	58,5	57,5	45	50	70	82A0404225
42	30	57	57,5	50	50	70	82A0404230
42	35	58	58	55	50	70	82A0404235
42	38	60,5	57,5	60	50	70	82A0404238

82A145



90° Elbow adaptor

Ø A	B	C	E	G	⌀	⌀ 1	Model
6	R1/8	30	21,6	10	19	12	82A1450618
6	R1/4	31	23,7	13,5	19	12	82A1450628
6	R3/8	31	25	12,8	19	14	82A1450638
8	R1/8	31,5	21,8	10	21	14	82A1450818
8	R1/4	31,5	25,3	13	21	14	82A1450828
8	R3/8	31	25	13,5	21	14	82A1450838
10	R1/8	33,5	22,4	10	24	14	82A1451018
10	R1/4	33,5	23,9	12	24	14	82A1451028
10	R3/8	33,5	25,2	14	24	14	82A1451038
12	R1/4	36,3	27	12	26	16	82A1451228
12	R3/8	36,3	27	11,9	26	16	82A1451238
14	R1/4	39,8	27,5	13,5	28	18	82A1451428
14	R3/8	38,8	27,5	12	28	18	82A1451438
14	R1/2	38,8	30	13,6	28	18	82A1451448
15	R1/4	36,8	27,5	13,5	30	20	82A1451528
15	R3/8	36,8	27,5	12	30	20	82A1451538
15	R1/2	36,8	30,5	13	30	20	82A1451548
16	R1/4	37,5	27,3	12	30	20	82A1451628
16	R3/8	38	27,8	12,5	30	20	82A1451638
16	R1/2	37	29,4	15	30	20	82A1451648
18	R3/8	40	28,3	12	32	22	82A1451838
18	R1/2	39,5	29,5	15	32	22	82A1451848
18	R3/4	39,5	32,3	17	32	20	82A1451868
20	R3/8	39,5	31,5	12	34	27	82A1452038
20	R1/2	39,5	31	12,6	34	27	82A1452048
20	R3/4	40	35,5	15	34	25	82A1452068
22	R1/2	39,5	32	13	38	27	82A1452248
22	R3/4	40	35,5	13	38	27	82A1452268
25	R1/2	43,5	37,2	14,5	38	32	82A1452548
25	R3/4	44,5	36	15	38	32	82A1452568
25	R1	43	38,2	20,5	38	32	82A1452588
28	R1/2	43,5	34,7	13,5	45	32	82A1452848
28	R3/4	44	36	15	45	32	82A1452868
28	R1	44,5	38,4	20,5	45	32	82A1452888
30	R3/4	50,5	44,1	15	50	38	82A1453068
30	R1	51	47,5	18	50	38	82A1453088
32	R3/4	50	44	15	50	40	82A1453268
32	R1	53	46	18	50	40	82A1453288
32	R1 1/4	50	47	18	50	40	82A14532A8
35	R3/4	51	46	15	55	41	82A1453568
35	R1	51	44,4	18	55	41	82A1453588
35	R1 1/4	52	48,5	19	55	41	82A14535A8
38	R3/4	58	48,5	16,5	60	50	82A1453868
38	R1	60	52	18	60	50	82A1453888
38	R1 1/4	60	51,7	18,5	60	50	82A14538A8
42	R1	58,8	51	18	70	50	82A1454288
42	R1 1/4	59	52,5	18,5	70	50	82A14542A8
42	R1 1/2	59	54,5	20	70	50	82A14542B8
42	R2	60	55	20	70	50	82A14542C8

82A246

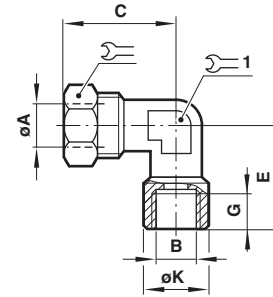

90° Elbow adaptor, female

Ø A	B	C	E	G	Ø K	⌀	⌀ 1	Model
6	G1/8	30,5	24	11	18	19	14	82A2460618
6	G1/4	33	30,5	12	22	19	18	82A2460628
8	G1/8	32	24	11	18	21	14	82A2460818
8	G1/4	34,5	30,5	12	22	21	18	82A2460828
8	G3/8	37	32,5	12,5	25	21	20	82A2460848
10	G1/8	35	25,5	11	18	24	14	82A2461018
10	G1/4	34,5	29,5	12	22	24	18	82A2461028
10	G3/8	36,5	32,5	12,5	25	24	20	82A2461038
10	G1/2	39	34,5	13	30	24	27	82A2461048
12	G1/4	40,8	30,5	12	22	26	16	82A2461228
12	G3/8	35,8	32,5	12,5	25	26	20	82A2461238
12	G1/2	39,8	36,5	13	30	26	27	82A2461248
14	G1/4	38,8	28	12	22	28	18	82A2461428
14	G3/8	39,8	32	12,5	25	28	20	82A2461438
14	G1/2	41,3	36,5	13	30	28	27	82A2461448
15	G1/4	36,8	28	12	22	30	18	82A2461528
15	G3/8	38,3	32,5	12,5	25	30	20	82A2461538
15	G1/2	39,8	40,5	13	30	30	27	82A2461548
16	G1/4	38,5	32,5	12	22	30	20	82A2461628
16	G3/8	37,5	33,5	12,5	25	30	20	82A2461638
16	G1/2	39,5	41	13	30	30	27	82A2461648
18	G3/8	39	31	12,5	25	32	22	82A2461838
18	G1/2	39,5	37	13	30	32	27	82A2461848
18	G3/4	40	41,5	15	37	32	25	82A2461868
20	G3/8	39,5	32,5	12,5	25	34	27	82A2462038
20	G1/2	39,5	36,5	13	30	34	25	82A2462048
20	G3/4	39,5	41,5	15	37	34	25	82A2462068
22	G3/8	40,5	33	12,5	25	38	27	82A2462238
22	G1/2	40	37	13	30	38	27	82A2462248
22	G3/4	40	41	15	37	38	27	82A2462268
25	G1/2	42,5	41	13	30	45	32	82A2462548
25	G3/4	42,5	44	15	37	45	32	82A2462568
25	G1	44	44	18	45	45	32	82A2462588
28	G3/4	44,5	44	15	37	45	32	82A2462868
28	G1	44,5	44,5	18	45	45	32	82A2462888
30	G3/4	50,5	45,5	15	37	50	39	82A2463068
30	G1	50	51,5	18	45	50	39	82A2463088
30	G1 1/4	54,5	49	20	55	50	50	82A24630A8
32	G1/2	50	45	13	30	50	40	82A2463248
32	G3/4	50	50	15	37	50	40	82A2463268
32	G1	50	51	18	45	50	40	82A2463288
32	G1 1/4	58	57,5	20	55	50	50	82A24632A8
35	G3/4	51,5	45,5	15	37	55	40	82A2463568
35	G1	51,5	51	18	45	55	40	82A2463588
35	G1 1/4	58	57,5	20	55	55	50	82A24635A8
38	G1	77	55	18	45	60	50	82a2463888
38	G1 1/4	79	57,5	20	55	60	50	82a24638A8
42	G1	57,5	56	18	45	70	50	82A2464288
42	G1 1/4	59,5	57,5	20	55	70	50	82A24642A8
42	G1 1/2	59,5	57,5	20	63	70	50	82A24642B8

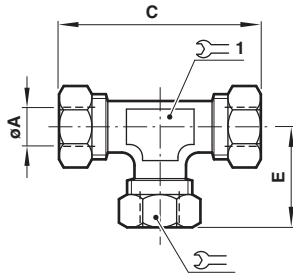
82A060

Union tee
(equal)

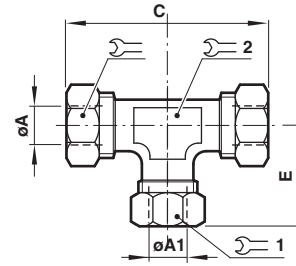
Ø A	C	E	1	1	Model
6	58	29	19	12	82A0600600
8	62	31	21	14	82A0600800
10	64	32	24	14	82A0601000
12	73,6	36,8	26	18	82A0601200
14	76,6	38,3	28	18	82A0601400
15	72,6	36,3	30	19	82A0601500
16	75	37,5	30	20	82A0601600
18	78	39	32	22	82A0601800
20	79	39,5	34	25	82A0602000
22	81	40	38	29	82A0602200
25	87	43,5	45	32	82A0602500
28	88	44	45	32	82A0602800
30	103	54,5	50	36	82A0603000
32	104	52	50	40	82A0603200
35	102	51	55	40	82A0603500
38	126	63	60	50	82A0603800
42	117	58,5	70	50	82A0604200

82A060

Union tee
(unequal)

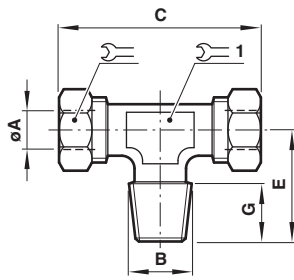
Ø A	Ø A1	C	E	1	1	2	Model
8	6	62	30	21	19	14	82A0600806
10	8	63	30,5	24	21	15	82A0601008
12	8	74	34,5	26	21	18	82A0601208
12	10	71	34,5	26	24	18	82A0601210
14	10	78,5	34,5	28	24	18	82A0601410
14	12	77,5	36	28	26	18	82A0601412
16	12	72	36	30	26	20	82A0601612
16	14	75,5	40,8	30	28	20	82A0601614
18	14	78	40,3	32	28	20	82A0601814
18	16	79	38	32	30	20	82A0601816
20	14	79,5	43,3	34	28	27	82A0602014
20	16	80	41	34	30	27	82A0602016
20	18	79	39,5	34	32	27	82A0602018
22	16	80,5	41	38	30	29	82A0602216
22	18	80,5	39	38	32	29	82A0602218
22	20	80,5	0	38	34	29	82A0602220
25	20	87,5	43	45	34	32	82A0602520
25	22	84,5	2	45	38	32	82A0602522
28	25	102	49,5	45	45	32	82A0602825
30	22	102	47	50	38	36	82A0603022
30	25	102	46,5	50	45	36	82A0603025
30	28	98	47,5	50	45	36	82A0603028
32	25	104	51	50	45	40	82A0603225
32	28	104	51,5	50	45	40	82A0603228
35	25	100	52	55	45	40	82A0603525
35	28	100	50,5	55	45	40	82A0603528
38	25	117	56	60	45	50	82A0603825
38	30	122	57	60	50	50	82A0603830
42	35	115	55,5	70	50	50	82A0604230
42	35	115	56	70	55	50	82A0604235

82A165



Tee adaptor

Ø A	B	C	E	G	⌀	⌀ 1	Model
6	R1/8	59	22	10	19	12	82A1650618
6	R1/4	59	21,5	12	19	12	82A1650628
8	R1/8	62,5	23,5	10	21	14	82A1650828
8	R1/4	62	24	12	21	14	82A1650848
10	R1/8	63	22	10	24	14	82A1651018
10	R1/4	65	24	12	24	14	82A1651028
10	R3/8	64,5	24	12	24	14	82A1651038
12	R1/4	70,1	26,5	12	26	18	82A1651228
12	R3/8	73,6	26,5	12	26	18	82A1651238
14	R1/4	76,6	27	12	28	18	82A1651428
14	R3/8	76,6	27	12	28	18	82A1651438
14	R1/2	78,6	29	13	28	18	82A1651448
15	R3/8	72,6	28	12	30	20	82A1651538
15	R1/2	72,6	30	13	30	20	82A1651548
16	R3/8	71	28	12	30	20	82A1651638
16	R1/2	72,5	30	13	30	20	82A1651648
18	R3/8	78,5	29,5	12	32	20	82A1651838
18	R1/2	76,5	30	13	32	20	82A1651848
18	R3/4	77,5	33	15	32	20	82A1651868
20	R3/8	80	31,5	12	34	27	82A1652038
20	R1/2	80	33	13	34	27	82A1652048
20	R3/4	80	35	15	34	27	82A1652068
22	R1/2	81	34	13	38	29	82A1652248
22	R3/4	81,5	35	15	38	29	82A1652268
25	R1/2	88	32,5	13	45	32	82A1652548
25	R3/4	88	34,5	15	45	32	82A1652568
25	R1	88	35	18	45	32	82A1652588
28	R3/4	85	34	15	45	32	82A1652868
28	R1	87,5	33,5	18	45	32	82A1652888
30	R3/4	101,5	38,5	15	50	37	82A1653068
30	R1	101	41,5	18	50	37	82A1653088
32	R3/4	101	39	15	50	40	82A1653268
32	R1	101	42	18	50	40	82A1653288
32	R1 1/4	101	42	18	55	40	82A1653588
35	R1 1/4	100	42	18	55	40	82A16535A8
38	R1	117	47	18	60	40	82A1653888
38	R1 1/4	117	48	18	60	40	82A16538A8
42	R1	117,5	47	18	70	50	82A1654288
42	R1 1/4	119	50	18	70	50	82A16542A8
42	R1 1/2	115	49	20	70	50	82A16542B8

82A266

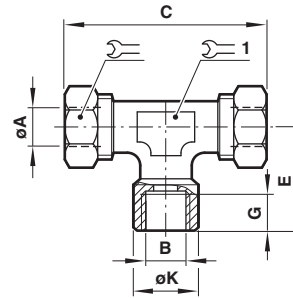

Tee adaptor, female

ØA	B	C	E	G	ØK	⌀	⌀ 1	Model
6	G1/8	56	27	11	18	19	12	82A2660618
6	G1/4	67,5	30	12	22	19	18	82A2660618
8	G1/4	68,5	30	12	22	21	18	82A2660828
8	G3/8	70	30	12,5	25	21	18	82A2660838
10	G1/8	69	30	11	18	24	18	82A2661018
10	G1/4	72,5	30	12	22	24	18	82A2661028
10	G3/8	70	30,5	12,5	25	24	18	82A2661038
10	G1/2	80	31	13	30	24	27	82A2661048
12	G1/4	72,6	30	12	22	26	18	82A2661228
12	G3/8	75,6	30,5	12,5	25	26	20	82A2661238
12	G1/2	78,6	31	13	30	26	27	82A2661248
14	G1/4	77,5	29	12	22	28	18	82A2661428
14	G3/8	82	30,5	12,5	25	28	20	82A2661438
14	G1/2	82	30,5	13	30	28	27	82A2661448
15	G3/8	73	32	12,5	25	30	21	82A2661538
15	G1/2	7,5	31	13	30	30	27	82A2661548
16	G3/8	76,5	32	12,5	25	30	20	82A2661638
16	G1/2	78,5	35,5	13	30	30	25	82A2661648
18	G3/8	80,5	30,5	12,5	25	32	22	82A2661838
18	G1/2	79	30	13	30	32	27	82A2661848
18	G3/4	80,5	33	15	37	32	27	82A2661868
20	G3/8	79,5	31	12,5	25	34	27	82A2662038
20	G1/2	79	31	13	30	34	27	82A2662048
20	G3/4	83,5	33,5	15	37	34	32	82A2662068
22	G1/2	81,5	31	13	30	38	29	82A2662248
22	G3/4	86,5	33	15	37	38	33	82A2662268
25	G1/2	85	32,5	13	30	45	33	82A2662548
25	G3/4	86,5	33,5	15	37	45	32	82A2662568
28	G3/4	90	33,5	15	37	45	32	82A2662868
28	G1	106	40,5	18	45	45	40	82A2662888
30	G3/4	102	39,5	15	37	50	36	82A2663068
30	G1	102,5	40,5	18	45	50	40	82A2663088
32	G3/4	104	41	15	37	50	40	82A2663268
32	G1	103,5	41	18	45	50	40	82A2663288
35	G3/4	103	40	15	37	55	40	82A2663568
35	G1	102	41	18	45	55	40	82A2663588
38	G1	117	49	18	45	60	50	82A2663888
42	G3/4	117	46,5	15	37	70	50	82A2664268
42	G1	117	49	18	45	70	50	82A2664288

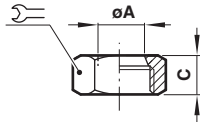
82A0F4

Tubing nut

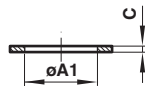
Ø A	C	≡	Model
6	13,5	19	82A0F40600
8	14	21	82A0F40800
10	15	24	82A0F41000
12	15,5	26	82A0F41200
14	16	28	82A0F41400
15	16	30	82A0F41500
16	16	30	82A0F41600
18	16	32	82A0F41800
20	16	34	82A0F42000
22	16	38	82A0F42200
25	17	45	82A0F42500
28	14,5	45	82A0F42800
30	14,5	50	82A0F43000
32	14,5	50	82A0F43200
35	18	55	82A0F43500
38	20	60	82A0F43800
42	20,5	70	82A0F44200

82A0E7

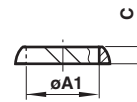
Tubing washer

For tube Ø	Ø A1	C	Model
6	6,5	1,5	82A0E70600
8	8,4	1,5	82A0E70800
10	10,4	1,5	82A0E71000
12	12,4	1,5	82A0E71200
14	14,2	1,5	82A0E71400
15	15,6	1,5	82A0E71500
16	16,2	1,5	82A0E71600
18	18,2	1,5	82A0E71800
20	20,2	1,5	82A0E72000
22	22,4	1,5	82A0E72200
25	25,5	2	82A0E72500
28	28,4	2	82A0E72800
30	30,2	2	82A0E73000
32	32,5	2	82A0E73200
35	35,5	2	82A0E73500
38	38,5	2	82A0E73800
42	42,9	2	82A0E74200

82A0J1

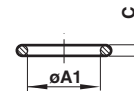
Split ring

Ø A	Ø A1	C	Model
6	6,2	4,5	82A0J10600
8	8,2	4,5	82A0J10800
10	10,2	5	82A0J11000
12	12,2	5	82A0J11200
14	14,2	5	82A0J11400
15	15,2	5	82A0J11500
16	16,2	5	82A0J11600
18	18,2	5	82A0J11800
20	20,2	5	82A0J12000
22	22,2	5	82A0J12200
25	25,2	5,5	82A0J12500
28	28,2	5,5	82A0J12800
30	30,2	5,5	82A0J13000
32	32,2	5,5	82A0J13200
35	35,2	6	82A0J13500
38	38,2	6	82A0J13800
42	42,2	6,5	82A0J14200

8000K

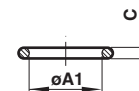
Tubing O ring - HNBR (yellow)

For tube Ø	Ø A1	C	Model
6	5,7	1,9	8000K20600
8	7,2	1,9	8000K20800
10	8,9	1,9	8000K21000
12	10,5	2,7	8000K21200
14 - 15	13,6	2,7	8000K21400
16	15,1	2,7	8000K21600
18	16,9	2,7	8000K21800
20	18,4	2,7	8000K22000
22	21,3	3,6	8000K22200
25	24,6	3,6	8000K22500
28	27,8	3,6	8000K22800
30	29,3	3,6	8000K23000
32	30,8	3,6	8000K23200
35	34,1	3,6	8000K23500
38	37,3	3,6	8000K23800
42	40,6	5,3	8000K24200

8000K

Thread O ring - ISO G male thread - HNBR (yellow)

For thread	Ø A1	C	Model
G1/8	8,9	1,9	8000K21000
G1/4	12,1	2,7	8000K30400
G3/8	15,1	2,7	8000K21600
G1/2	19,8	3,6	8000K30700
G3/4	24,6	3,6	8000K22500
G1	30,8	3,6	8000K23200
G1 1/4	37,5	5,3	8000K41100
G1 1/2	43,8	5,3	8000K24500
G2	56,5	5,3	8000K41300

Warning

These products are intended for use in industrial compressed air and rail transport systems. Do not use these products where pressures and temperatures can exceed those listed under 'Technical Data'.

Before using these products with fluids other than those specified, for non-industrial applications, life-support systems, or other applications not within published specifications, consult NORGREN.

Through misuse, age, or malfunction, components used in fluid power systems can fail in various modes.

The system designer is warned to consider the failure modes of all component parts used in fluid power systems and to provide adequate safeguards to prevent personal injury or damage to equipment in the event of such failure.

System designers must provide a warning to end users in the system instructional manual if protection against a failure mode cannot be adequately provided.

System designers and end users are cautioned to review specific warnings found in instruction sheets packed and shipped with these products.